



CONSUMERAFFAIRS
★★★★★ 4.8/5

Freecurve Curved Stairlift

Uniquely Crafted for You and Your Home

“I love how my Freecurve was custom built just for my home; my dealer provided so many options to personalize it just for me. Traveling up and down my staircase has never been easier with my new Handicare stairlift.”

Features

Single Tube Rail System

Compact and Foldable

Multiple Rail Color
and Seat Options

Easy to Use and Maintain

Available Active Seat, Powered
Footrest, Turn and Go and
Seat Swivel Options

Obstruction Free Add-ons for
Top and Bottom Landings



Safe Working Load (SWL)
275 lb (125 kg)



Warranty

Freecurve: 2 years
Motor and gearbox: Limited Lifetime



Regain your independence and conquer the struggles of staircases.

Handicare offers stairlift solutions that provide freedom of movement throughout your home, allowing you to age in place free from everyday obstacles. Our compact and customized stairlifts can be installed anywhere. We have millions of satisfied customers worldwide with a dealer network across North America to support you.

Limitless design options. Revolutionary single tube rail.

The Handicare Freecurve Curved Stairlift features a revolutionary design that takes up less space on stairs with custom features providing limitless options. Spiral, narrow, and steep staircases present no challenge to the Freecurve thanks to its single tube rail, engineered to fit any home with a curved staircase.

Easy to maintain with a quiet and smooth ride that provides the ultimate in safety and comfort. The Freecurve is available in a unique, elegant design in a variety of seat styles and rail color options to match your home décor and personal taste.



Did You Know?

We have over 700,000
satisfied customers
around the world.

Features for Your Safety and Convenience



Compact

The Freecurve folds up easily maximizing the space for family members to go up and down the stairs as needed when not in use.



Did You Know?

Crafted for your staircase.

Each Freecurve stairlift rail is designed and manufactured specifically to fit your staircase, ensuring an accurate fit to maximize space for other stair users.



Easy to Use

Ergonomic and intuitive to use, the joystick on the armrest smoothly operates the Freecurve.

Send for your stairlift at the touch of a button with the included remote control. Two are included with your Freecurve with holders for both the top and bottom landings.

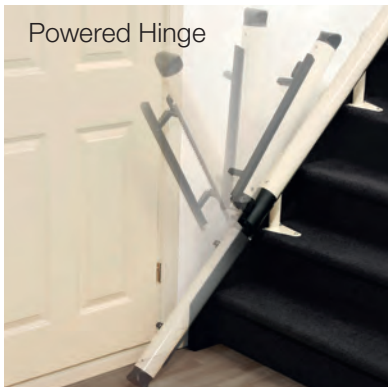

Powered Hinge

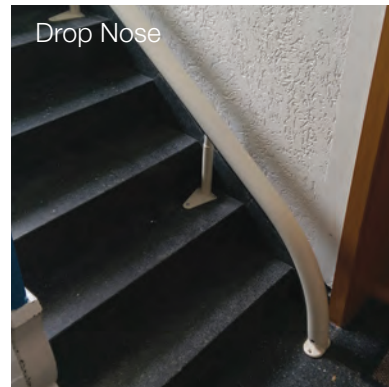

Drop Nose

Adaptable

Combine your stairlift with a powered hinge or drop nose option to prevent the track from obstructing a doorway at the base of the stairs.



Multiple Charge Points

Charge points are conveniently located at the top and bottom of stairs for pain-free recharging.

Additional charge points can be added for flexibility and convenience.



Turn and Go

Narrow staircases are not a problem for the Freecurve, the optional Turn & Go feature automatically swivels your seat forward while riding. A convenient solution that allows more room for the user in tight environments.



Stairlift Myth

"Maintaining a stairlift is expensive."

Cost-effective parts, maintenance friendly design, and Handicare's industry-leading warranty make the Freecurve the smart choice.



Active Seat

The optional Active Seat option makes sitting down or getting up from your Freecurve much easier. With just a pull of a lever your movements are supported, keeping strain off your joints and muscles. (Available with Alliance and Elegance seats.)



Safety First

The optional powered footrest allows you to fold and unfold the footrest without having to bend down, LED illumination improves visibility in low lit areas (standard with the powered footrest) and an anti-slip texture providing better foot grip when seated and departing.

The Freecurve is also equipped with an easy-to-use retractable seat belt and fitted with multiple safety sensors which stop the stairlift whenever it runs into an obstacle.



Automatic Swivel

The optional powered swivel makes it easy to get off the lift at the top of landings, simply hold the toggle switch in the direction of the landing to turn the seat for a controlled departure. With 80 degrees of tilt, you face more of your top landing providing greater security when getting up from your Freecurve stairlift. (Manual swivel standard.)

Tailor Made for You and Your Home!



Alliance Seat

The Alliance seat has a refined appearance making it a welcome addition to any interior. The two-tone combination of wood and leatherette upholstery makes the seat truly stand out.

Options

- Powered Swivel ✓
- Powered Footrest ✓
- with LED Illumination
- Turn and Go ✓
- Active Seat ✓
- Body Harness ✓
- Child Seat ✓

Seat Colors



Bordeaux Red



Beige



Cocoa Brown



Elegance Seat

The Elegance seat combines luxurious design with ultimate comfort, thanks to its super-soft leatherette upholstery. The seat looks and feels stylish with a elegant feel. Armrests can also be adjusted outwards to create a wider seat.

Options

- Powered Swivel ✓
- Powered Footrest ✓
- with LED Illumination
- Turn and Go ✓
- Active Seat ✓
- Body Harness ✓
- Child Seat ✓

Seat Colors

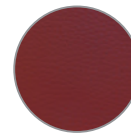

Bordeaux Red



Beige



Cocoa Brown



Classic Seat

The Classic seat is extremely comfortable and designed with input from therapists. The seat comes in a leatherette-grain finish offering a timeless ergonomic design.

Options

- Powered Swivel ✓
- Powered Footrest ✓
- with LED Illumination
- Turn and Go ✓
- Active Seat ✗
- Body Harness ✗
- Child Seat ✓

Seat Colors

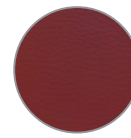

Bordeaux Red



Beige

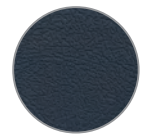

Slate

Choose from 3 Standard Rail Colors
Custom color available with additional surcharge



Cream White

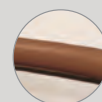

Brown



Grey

Frequently Asked Questions

We strive for 100% customer satisfaction. That is why we go the extra mile to offer you the highest standards of service and answer your questions in the best way possible. We partner with the industry's leading dealers that have a track record of exceptional local support.

We have listed some of our customers' most frequently asked questions. Should you have further questions, please contact your local dealer for a consultation.



Can a stairlift be installed on my staircase?

Handicare offers a wide selection of stairlifts for straight and curved stairs. With a variety of lift models we are able to provide a suitable solution for each setting regardless of whether the stairs are narrow, steep, curved or long, indoor or outdoor. Handicare always has a solution for your staircase.

Does it take major renovation to install a stairlift in my home?

No! The Freecurve Curved Stairlift is simply installed onto the stair treads. Because it is fixed to the staircase, you don't have to worry about any further modification to your home.

How do I enter and exit from a stairlift?

Entering and exiting the Freecurve is made easy, simply unfold the seat and footrest, sit down and secure the seat belt. When it's time to exit your Freecurve, you can easily swivel the seat to face your landing for a controlled departure.

Can others still use my stairs?

Compact and ultra slim, the Freecurve can easily be folded up when not in use to allow easy pass-through for family members and friends.

What happens to my stairlift during a power outage?

A power failure is no reason to worry. Your Handicare stairlift will use its batteries to remain operational and can still be used for at least 10 rides up and down the stairs.



Freecurve Fact!

Our patented PhotoSurvey software allows you to see what your Freecurve will look like on your staircase before placing your order!

Freecurve Curved Stairlift

Specifications

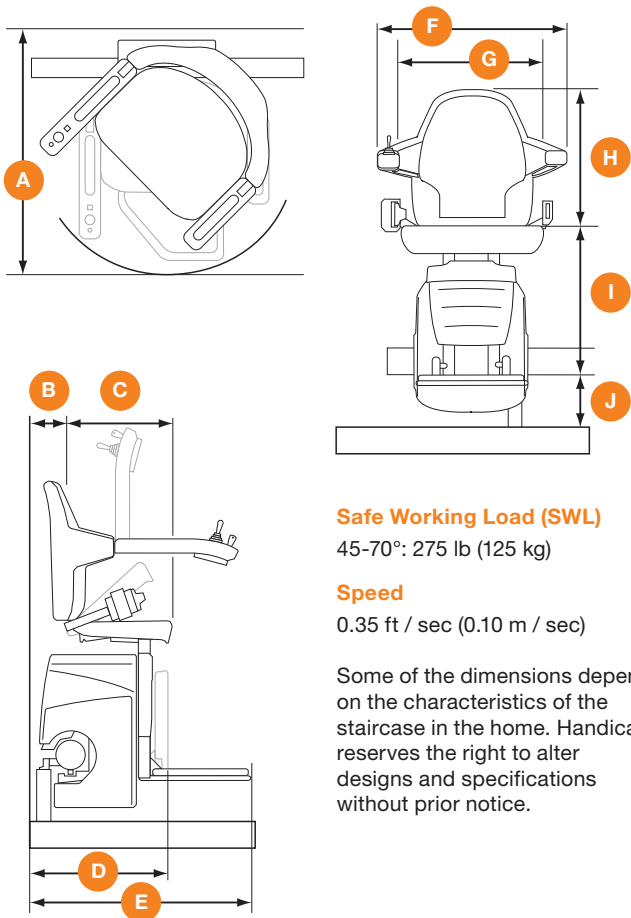

Safe Working Load (SWL)
45-70°: 275 lb (125 kg)

Speed
0.35 ft / sec (0.10 m / sec)

Some of the dimensions depend on the characteristics of the staircase in the home. Handicare reserves the right to alter designs and specifications without prior notice.

Freecurve Style Seat Dimensions

A Swivel radius	28.4–29.5 in (721–749 mm)
B Wall to inner seat back	4.1–5.1 in (105–130 mm)
C Seat depth	14.5–15 in (368–381 mm)
D Folded width to footrest, minimum	16.5–17.4 in (419 mm)
E Open width to edge of footrest, minimum	25.1–26 in (638–660 mm)
Offset footrest	24–24.8 in (607–629 mm)
F Armrest width, external	22.1–23.5 in (562–597 mm)
G Armrest width, internal	17.1–18.3 in (435–464 mm)
H Seat back height	15.5–16.4 in (394–416 mm)
I Footrest to seat height	18.6–19.5 in (473–495 mm)
J Footrest height, minimum	3.9–4.9 in (98–124 mm)
Track intrusion into staircase, minimum	6.8–7.5 in (171–191 mm)
Weight limit, maximum	275 lb (125 kg)

*Dimensions vary based on seat style selected and may vary depending on hand of seat.
**Seat depicted in specification drawings is our Classic Seat.

Are you ready to take back your independence with the Freecurve?

To learn more, call 1-888-637-8155 or visit www.handicareusa.com / handicare.ca